



universal hammock frame



150kg capacity
suitable for hammocks up to 390cm long

Instructions

ASSEMBLY:

a	Hook	2
b	Female Extension pipe, 42mm DIA x 980mm	2
c	Male Connector	2
d	End Angle tube	2
e	Mid base male spreader tube, 36.5mm DIA x 740mm	1
f	Stabiliser tube, 40mm DIA x 980mm	2
g	Feet (tubular)	4
h	Inside collar	4
i	External collar	6
j	Tri-wing screws	14
k	Wheels with connection pipe	2

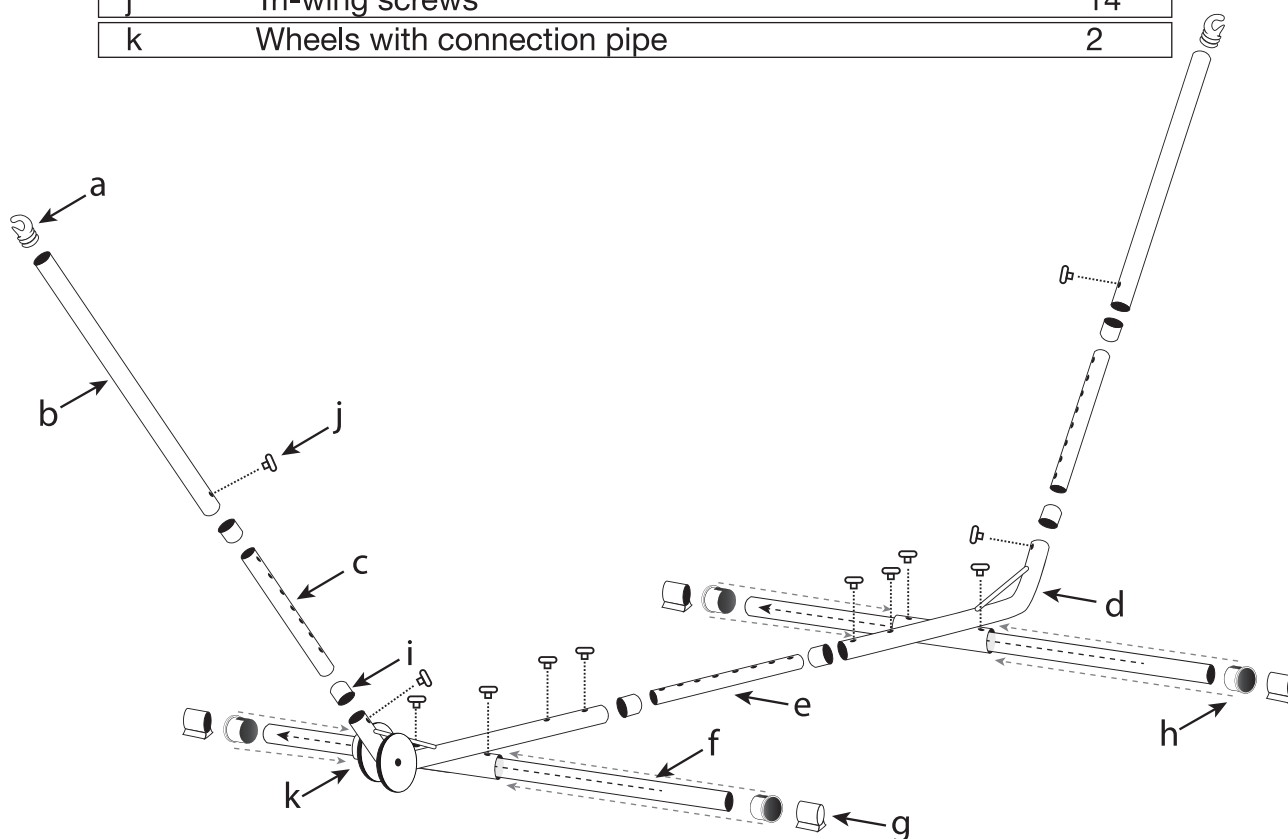

For more information visit www.twotreeshammocks.com.au

We will honour all statutory guarantees that this product is of acceptable quality (including that it is fit for purpose)

Made in China exclusively for Mayo Hardware Pty Ltd, 34 Morley Avenue, Rosebery, NSW, 2018, Australia

Customer Service Phone: 1300 360 211, www.mayohardware.com.au, 2011©

two trees

HAMMOCKS

step by step guide

- 1.** Connect item "k" with stabiliser tubes (f). Ensure to place inside collars (h) on either side of the wheel pipe (k) and secure with two screws (j). Repeat with the end angle tube (d).

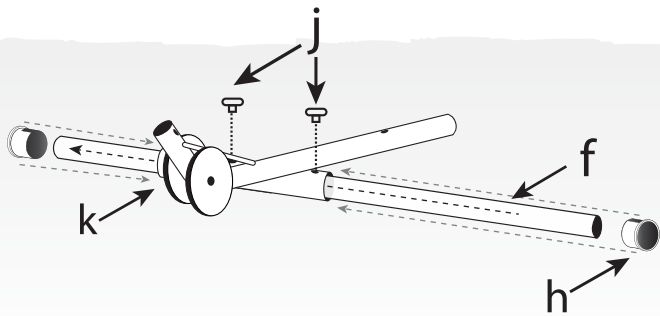

- 2.** Take one of the male spreader tube (e) and join both wheel (k) and angle tube (d) together. Be sure to insert external collars (i) on either side of the male spreader tube (e). Four screws (j) will be needed to fix this in place.

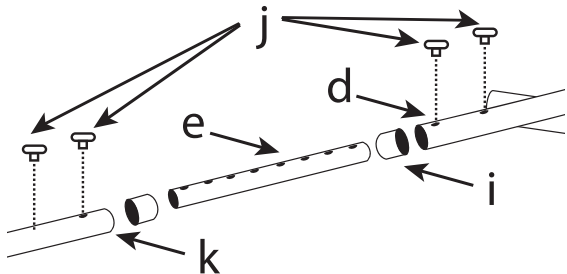

- 3.** Attach one male connector pipe (c) on top of each parts (k) and (d) to build the base of the side arms. Be sure to use an external collar (i) in between pipes. One screw (j) on each side will be needed to fix this into place.

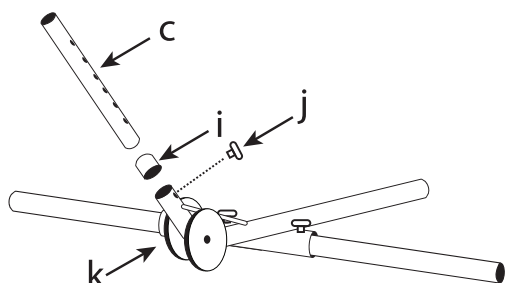

- 4.** Connect the female extension pipes (b) to the male connector pipes (c). The female extension pipe (b) can sit at varying heights. Adjust the height so that the hammock does not touch the ground when in use. Ensure to use external collars (i) when connecting the female extension pipe (b) to the male connector (c).

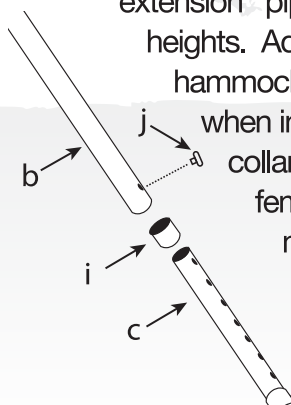

- 5.** Take the hooks (a) and insert into the female extension pipes (b) on either side. Ensure that the hooks finger faces outwards so that the hammock cannot slip out of the hook when being used.

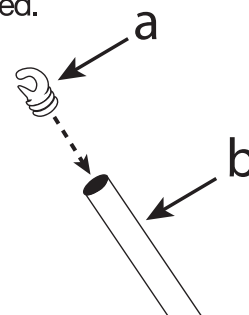

- 6.** Take the tubular feet (g) and attach to each end of the stabiliser tubes (f).

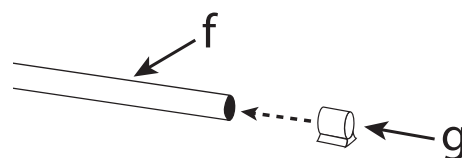

Now you are ready to hang your hammock into the hooks end.

Start relaxing.